

OPERATION – UTILIZAÇÃO – FONCTIONNEMENT – FUNCIONAMIENTO ULTRA® MAX 695/795/1095/1595/Mark V



309257

Rev. C

All models not available in all countries.
Nem todos os modelos existem à disposição em todos os países.
Tous les modèles ne sont pas disponibles dans tous les pays.
Hay modelos que no se distribuyen en todos los países.

3300 psi (227 bar, 22.7 MPa) Maximum Working Pressure)
Pressão máxima de trabalho de 3300 psi (227 bar, 22.7 MPa)
Pareasion maximale de service 3300 lb/po² (227 bar, 22.7 MPa)
Presión máxima de operación 3300 psi (227 bar, 22.7 MPa)

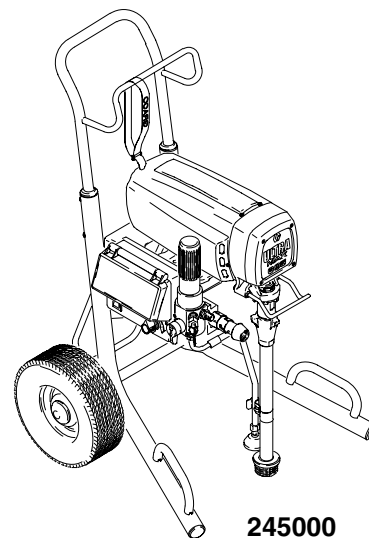

245000

T10765A



Related manuals
Manuais associados
Manuels afférents
Manuales relacionados



..... 309251 (695/795/1095)

..... 309266 (1595/Mark V)



AutoClean

..... 309278



..... 309250



..... 309639











..... 309640



..... 309252 309263 (695)

..... 309260 309261 (795/1095)

..... 309267 309268 (1595/Mark V)

INSTRUCTIONS	INSTRUÇÕES
<p>READ ALL INSTRUCTIONS AND WARNINGS BEFORE SETTING UP OR OPERATING THIS UNIT.</p> <p>You need:</p> <ul style="list-style-type: none"> two adjustable wrenches two 5 gallon (19 liters) metal pails compatible cleaning fluids <div style="display: flex; justify-content: space-around;"> <div style="text-align: center;">  Oil Base </div> <div style="text-align: center;">  Latex </div> </div> <p>Power: grounded outlet</p> <p>Japan: 100V, 15A United Kingdom: 110V, 15A North/Latin Am: 120V, 15A Europe/South Am: 230V, 10A Australia/Asia: 240V, 10A</p> <ul style="list-style-type: none"> 12 AWG, (1.5 mm²) grounded extension cord up to 300 feet (100 M) <p>Clothing:</p> <ul style="list-style-type: none"> respirator safety glasses 	<p>LEIA TODAS AS INSTRUÇÕES E ADVERTÊNCIAS ANTES MONTAR OU UTILIZAR ESTA UNIDADE.</p> <p>Você precisa de:</p> <ul style="list-style-type: none"> duas chaves inglesas dois baldes metálicos de 20 litros líquidos de limpeza compatíveis <div style="display: flex; justify-content: space-around;"> <div style="text-align: center;">  À base de óleo </div> <div style="text-align: center;">  Látex </div> </div> <p>Potência elétrica: tomada ligada à terra</p> <p>Japão: 100V, 15A Reino Unido: 110V, 15A América do Norte/Latina: 120V, 15A Europa/América do Sul: 230V, 10A Austrália/Ásia: 240V, 10A</p> <ul style="list-style-type: none"> 12 AWG, (1,5 mm²) fio de extensão ligado à terra até 100 M <p>Vestuário:</p> <ul style="list-style-type: none"> máscara de respiração óculos protetores
INSTRUCTIONS	INSTRUCCIONES
<p>LIRE TOUTES LES INSTRUCTIONS ET AVERTISSEMENTS AVANT DE PRÉPARER OU FAIRE FONCTIONNER CET APPAREIL.</p> <p>Matériel requis :</p> <ul style="list-style-type: none"> deux clés à molette deux seaux métalliques de 5 gallons (19 litres) nettoyants liquides compatibles <div style="display: flex; justify-content: space-around;"> <div style="text-align: center;">  Émail (base d'huile) </div> <div style="text-align: center;">  Latex </div> </div> <p>Alimentation électrique : prise mise à la terre</p> <p>Japon : 100V, 15A Royaume-Uni : 110V, 15A Amérique du Nord / Latine : 120V, 15A Europe / Amérique du Sud : 230V, 10A Australie / Asie : 240V, 10A</p> <ul style="list-style-type: none"> 12 AWG, (1.5 mm²) cordon prolongateur mis à la terre 300 pi (100 m) max. <p>Protection personnelle :</p> <ul style="list-style-type: none"> respirateur lunettes de protection 	<p>LEA TODAS LAS INSTRUCCIONES Y ADVERTENCIAS ANTES DE PREPARAR U OPERAR ESTA UNIDAD.</p> <p>Necesita:</p> <ul style="list-style-type: none"> dos llaves ajustables dos recipientes metálicos de 20 litros (5 galones) fluidos de limpieza compatibles <div style="display: flex; justify-content: space-around;"> <div style="text-align: center;">  Óleo </div> <div style="text-align: center;">  Látex </div> </div> <p>Potencia eléctrica: toma de corriente puesta a tierra</p> <p>Japón: 100V, 15A Reino Unido: 110V, 15A América del Norte/Latina: 120V, 15A Europa/ América del Sur: 230V, 10A Australia/Asia: 240V, 10A</p> <ul style="list-style-type: none"> Cordón de extensión con tierra de 12 AWG (1.5 mm²) de hasta 100 metros (300 pies) <p>Vestuário:</p> <ul style="list-style-type: none"> mascarilla gafas de seguridad

GRACO INC. P.O. BOX 1441 MINNEAPOLIS, MN 55440-1441

Graco Inc. is registered to I.S. EN ISO 9001

⚠ WARNING

Fire and explosion hazard: Solvent and paint fumes can ignite or explode.

To help prevent a fire and explosion:

- Use only in an extremely well ventilated area.
- Eliminate all ignition sources; such as pilot lights, cigarettes and plastic drop cloths (static arc hazard). Do not plug or unplug power cords or turn lights on or off in spray area.
- Ground Sprayer, object being sprayed, paint and solvent pails.
- Hold gun firmly to side of grounded pail when triggering into pail.
- Use only conductive airless paint hose.
- Do not use 1,1,1-trichloroethane, methylene chloride, other halogenated hydrocarbon solvents or fluids containing such solvents in pressurized aluminum equipment. Such use could result in a chemical reaction, with the possibility of explosion.

Fluid injection and high pressure hazard: High pressure spray or leaks can inject fluid into the body.

To help prevent injection, always:

- Engage trigger safety latch when not spraying.
- Keep clear of nozzle and leaks.
- Never spray without a tip guard.
- Do **PRESSURE RELIEF** if you stop spraying or begin servicing sprayer.
- Do not use components rated less than sprayer *Maximum Working Pressure*.
- Never allow children to use this unit.

If high pressure fluid pierces your skin, the injury might look like "just a cut". But it is a serious wound! Get immediate medical attention.

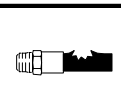

⚠ ADVERTÊNCIA

Perigo de incêndio e explosão: os solventes e os vapores da pintura poderão explodir ou incendiar.

Para ajudar a evitar incêndio e explosão:

- Utilize unicamente em áreas extremamente bem ventiladas.
- Elimine todas as fontes de ignição, tais como luzes piloto, cigarros e arcos de estática resultantes dos plásticos de proteção. Não ligue nem desligue os cabos de alimentação ou as luzes numa área de pulverização.
- Ponha em contato com a terra o pulverizador, o objeto a ser pulverizado, e os baldes de tinta e de solventes.
- Segure a pistola firmemente de encontro ao lado do balde em contato com a terra, quando estiver descarregando para dentro do mesmo.
- Utilize somente tubos flexíveis condutores para pintura a alta pressão.
- Não utilize 1,1,1-tricloroetano, cloro de metileno, outros solventes de hidrocarbonetos halogenados ou líquidos contendo tais solventes em equipamento de alumínio pressurizado. Tal utilização poderá resultar numa reação química, com possibilidade de explosão.

Perigo de injeção de líquidos à alta pressão: a pulverização ou vazamentos à alta pressão podem injetar líquido no corpo.

Para ajudar a evitar injeção de líquido, faça sempre o seguinte:

- Engate o trinco de segurança do gatilho quando não estiver pulverizando.
- Mantenha-se afastado dos bocais e locais onde há vazamentos.
- Nunca pulverize sem que haja uma proteção na extremidade.
- **ALIVIE A PRESSÃO** quando parar de pulverizar e antes de iniciar a manutenção do pulverizador.
- Não utilize componentes com uma classificação inferior à do pulverizador *Pressão Máxima de Trabalho*.
- Nunca permita que crianças utilizem esta unidade.

Se o líquido a alta pressão penetrar na sua pele, o ferimento poderá parecer "simplesmente um corte". Mas é um ferimento grave! Procure o médico imediatamente.

⚠ MISE EN GARDE

Danger d'incendie et d'explosion : les gaz de solvant et de peinture peuvent s'enflammer ou exploser.

Pour éviter les risques d'incendie et d'explosion :

- N'utiliser l'appareil que dans une zone extrêmement bien aérée.
- Éliminer toute source d'inflammation ; telle que veilleuses, cigarettes et arcs d'électricité statique créés par les toiles de peintre en plastique. Ne pas brancher et débrancher de cordons électriques, ou allumer et éteindre des lumières dans la zone de pulvérisation.
- Mettre à la terre le pulvérisateur, l'objet à pulvériser ainsi que les seaux de peinture et de solvants.
- Tenir le pistolet fermement contre la paroi d'un seau mis à la terre lorsqu'on pulvérise dans le seau.
- N'utiliser qu'un flexible pour peinture pulvérisée sans air.
- Ne jamais utiliser de trichloroéthane 1,1,1, de chlorure de méthylène, d'autres solvants à base d'hydrocarbures halogénés, ni de produits contenant de tels solvants dans un équipement sous pression en aluminium. Cela pourrait provoquer une réaction chimique avec risque d'explosion.

Danger d'injection de fluide et haute pression : la pulvérisation sous haute pression ou les fuites peuvent injecter des fluides dans le corps.

Pour éviter les risques d'injection, toujours :

- Bloquer le loquet de sécurité de la gâchette à la fin de la pulvérisation.
- Se tenir loin de la buse et des fuites.
- Ne jamais pulvériser sans anti-gouttes.
- **DÉCHARGER LA PRESSÃO** à la fin de la pulvérisation ou avant de réparer le pulvérisateur.
- Ne pas utiliser de composants dont la pression nominale est inférieure à la *pression maximale de service du système*.
- Ne jamais permettre aux enfants d'utiliser cet appareil.

Si un fluide haute pression perce la peau, la blessure peut paraître une "simple coupure" Mais il s'agit bien d'une lésion grave! Consulter immédiatement un médecin.

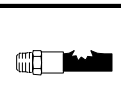

⚠ ADVERTENCIA

Peligro de incendio o explosión: Los gases de los disolventes y de la pintura pueden inflamarse o provocar una explosión.

Para prevenir incendios y explosiones:

- Use únicamente en un área muy bien ventilada.
- Suprima todas las fuentes de ignición; como luces piloto, cigarrillos y arcos estáticos de carpetas plásticas para protección contra pintura. No enchufe ni desenchufe cables de alimentación ni apague ni encienda las luces en un área de pulverización.
- Ponga a tierra el pulverizador, el objeto que recibe el chorro pulverizado, las cubetas de pintura y disolvente.
- Sostenga firmemente la pistola a un lado de la cubeta puesta a tierra cuando dispare dentro de ella.
- Use solamente mangueras para pintura conductora sin aire.
- No utilice nunca tricloroetano-1,1,1, cloruro de metileno ni otros disolventes a base de hidrocarburos halógenos o fluidos que contengan dichos disolventes en un equipo a presión de aluminio. El uso de estas sustancias puede provocar una intensa reacción química, con riesgos de explosión.

Peligro de inyección de fluido y alta presión: por la pulverización o las filtraciones a alta presión se pueden inyectar fluidos en el organismo.

Para prevenir la inyección en la piel, siempre:

- Enganche el seguro del gatillo cuando no use el pulverizador.
- No se acerque a la boquilla ni a las filtraciones.
- Nunca aplique fluido pulverizado sin un guardaboquilla.
- Realice el **ALIVIO DE PRESSÃO** si deja de pulverizar fluido o repara el pulverizador.
- No use componentes de capacidad nominal inferior a la *presión máxima de operación del pulverizador*.
- No permita que niños usen esta unidad.

Si fluido de alta presión le penetra la piel, la lesión podría parecer "sólo un corte". ¡Es una lesión seria! Consulte de inmediato al médico.

CONTROLS / CONTROLES / COMMANDES / CONTROLES

***Pressure Display / Indicador de pressão
Afficheur de pression / Visor de presión**



***Not available on all sprayers /
Nao disponível em todos os pulverizadores /
Non disponible sur tous les pulvérisateurs /
No disponible en todos los rociadores**

**Drain Valve / Válvula de drenagem
Vidange / Válvula de vaciado**

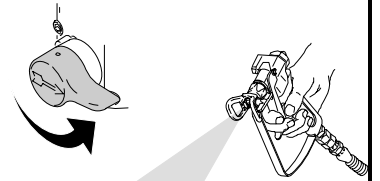

**On/Off Switch / Interruptor de ligar e
desligar (On/Off) / Interrupteur marche /
arrêt / Interruptor de encendido/apagado**

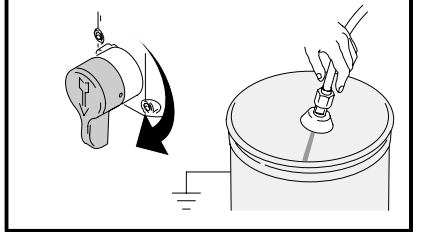
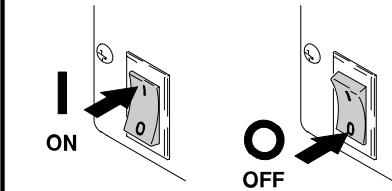

**15/20 Ampere Switch
Interruptor de 15/20 ampères
Commutateur de 15/10 ampères
Interruptor de 15/20 amperios**

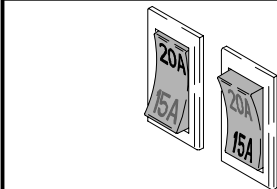

***AutoClean™ 309278**

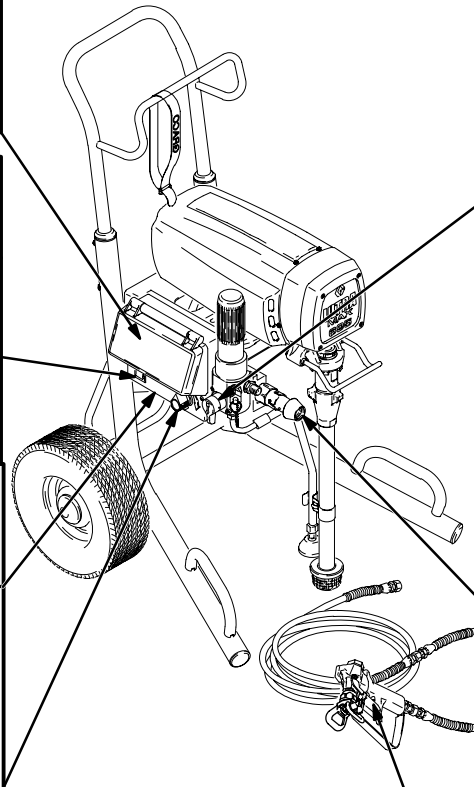
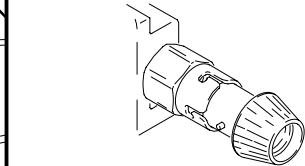

**Pressure Control / Controle da pressão
Régulation de pression / Dispositivo de
control de la presión**

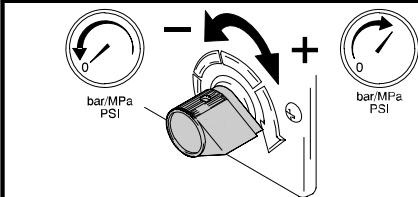

**Trigger Lock / Fecho do gatilho
Loquet de sécurité / Seguro del gatillo**

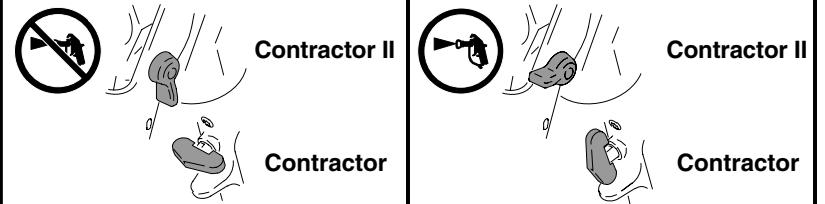

PRESSURE RELIEF / ALÍVIO DE PRESSÃO / DÉCHARGE DE PRESSION / ALIVIO DE LA PRESIÓN

**Follow 1–5 when you stop
spraying.
Siga os passos de 1–5
quando parar de pulverizar.
Suivre les étapes 1 à 5
lorsqu'on arrête de pulvériser.
Siga los pasos 1–5 cuando
deje de usar el pulverizador.**

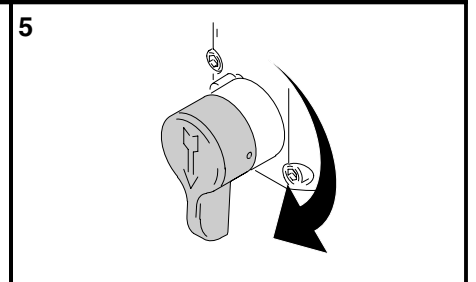
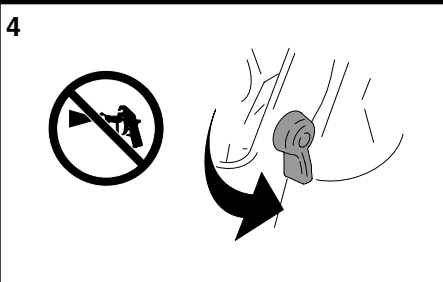
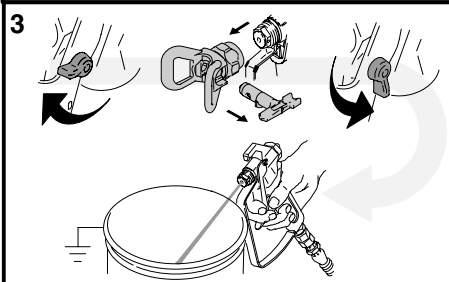
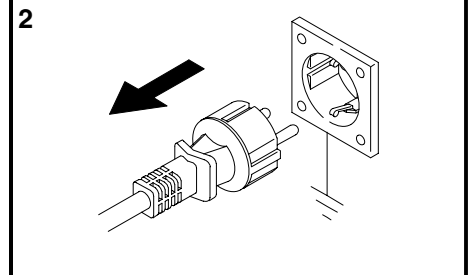
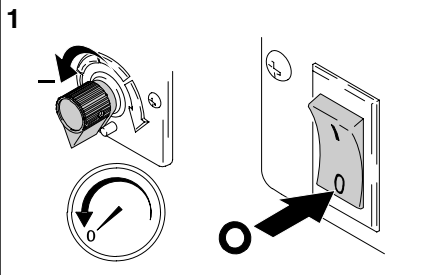

STARTUP / PARTIDA / MISE EN ROUTE / PUESTA EN MARCHA

Flush with warm, soapy water.

Faça a descarga com água morna e sabão dissolvido.

Rincer avec de l'eau tiède savonneuse

Enjuague con agua tibia con jabón.



1



2

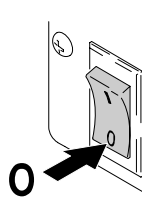

3

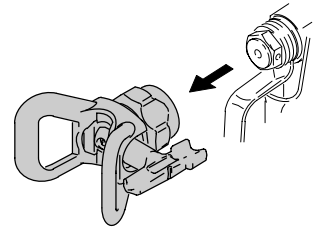

Flush with mineral spirits.

Faça a descarga com álcool mineral.

Rincer avec une essence minérale.

Enjuague con alcohol mineral.



Flush / Descarga / Vidange / Enjuague 4→11

4



5

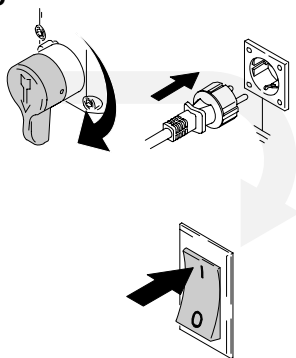

6

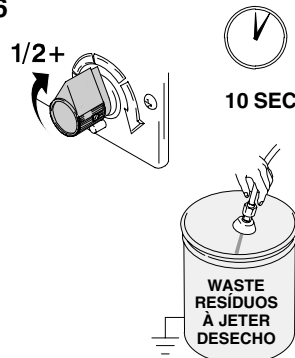

7

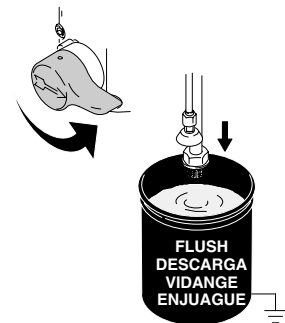

8

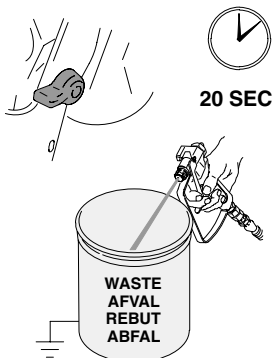

9



10

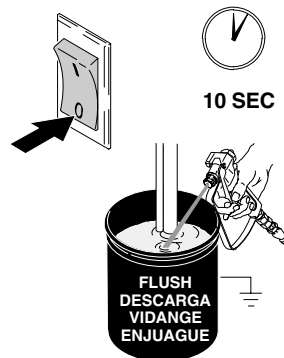

11



Prime / Preparação / Amorçage / Cebado 12→15

12

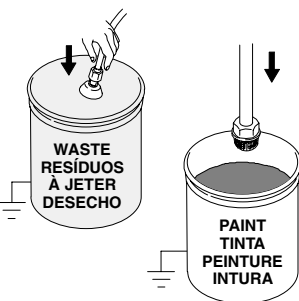

13

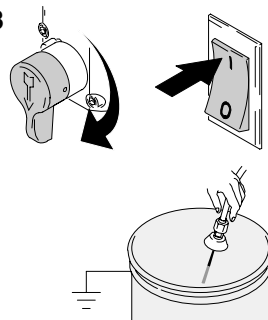

Watch for paint.
Cuidado com a tinta.
Vérifier l'arrivée de la peinture.
Observe cuando salga pintura.

14



15

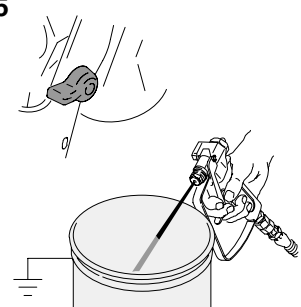

Watch for paint.
Cuidado com a tinta.
Vérifier l'arrivée de la peinture.
Observe cuando salga pintura.

SPRAY / PULVERIZAÇÃO / PULVÉRISATION / PULVERIZACIÓN

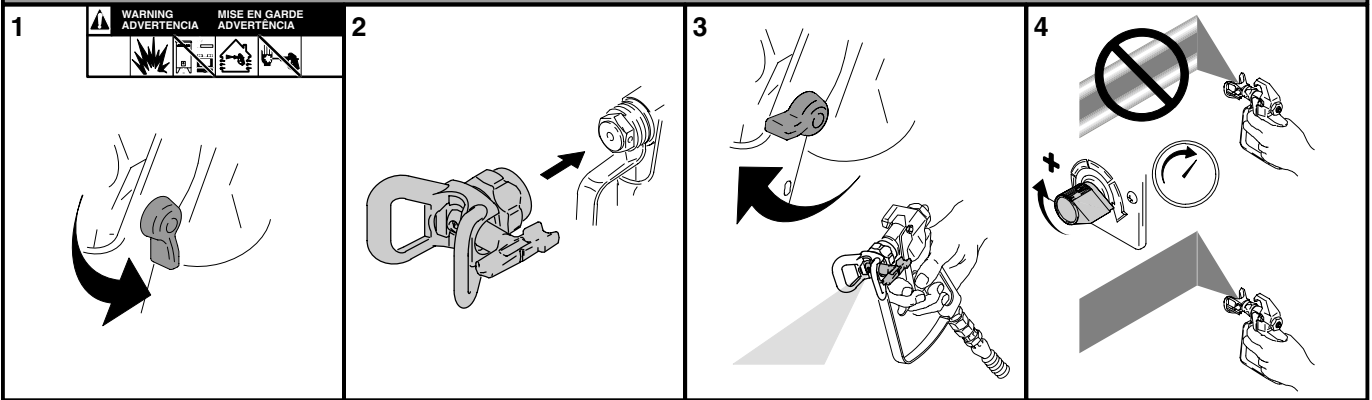

CLEAR CLOG / DESOBSTRUÇÃO / DÉCRASSEMENT / DESTAPE

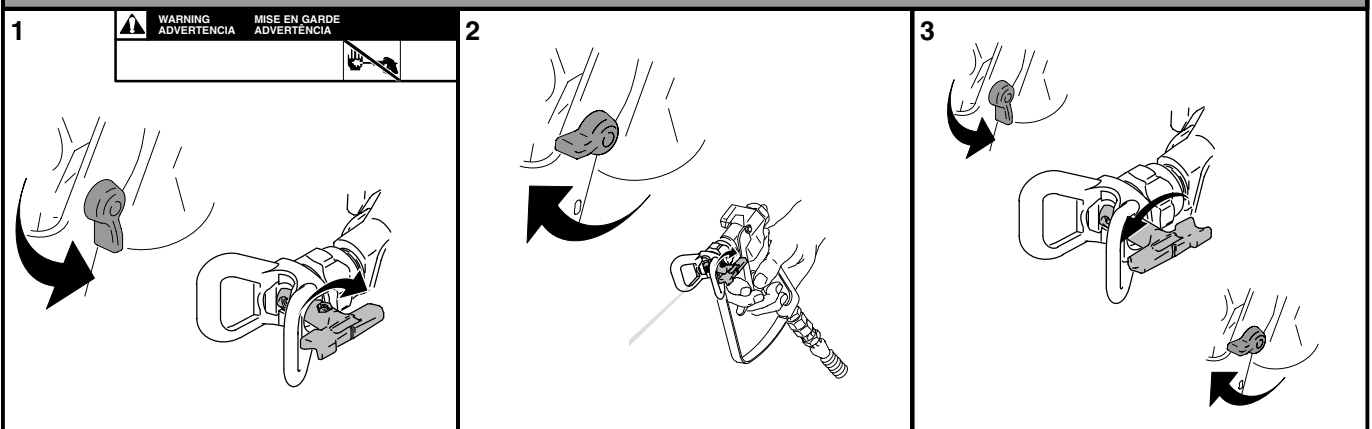

**CHANGE PAINT / TROCA DE TINTA
CHANGEMENT DE PEINTURE / CAMBIE PINTURA**

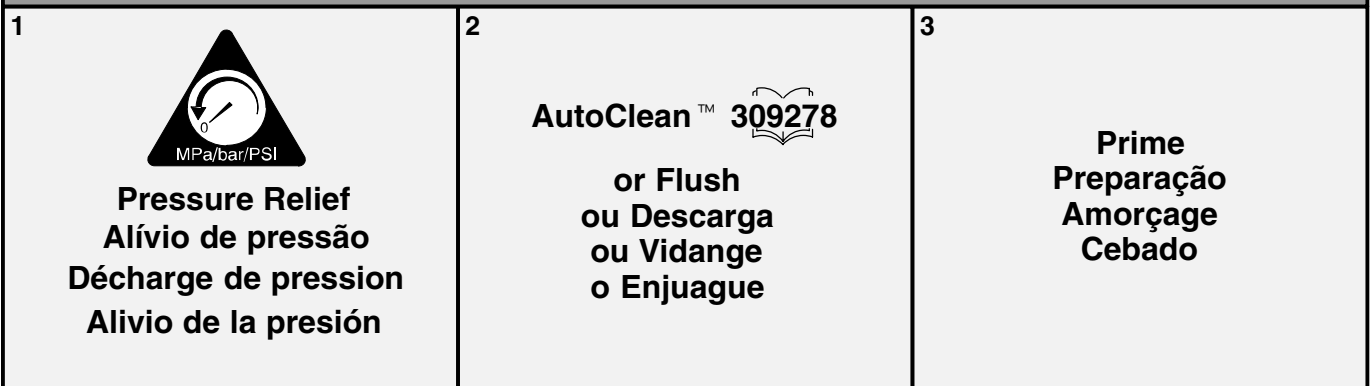

GROUNDING / MISE À LA TERRE / LIGAÇÃO A TERRA / CONEXIÓN A TIERRA

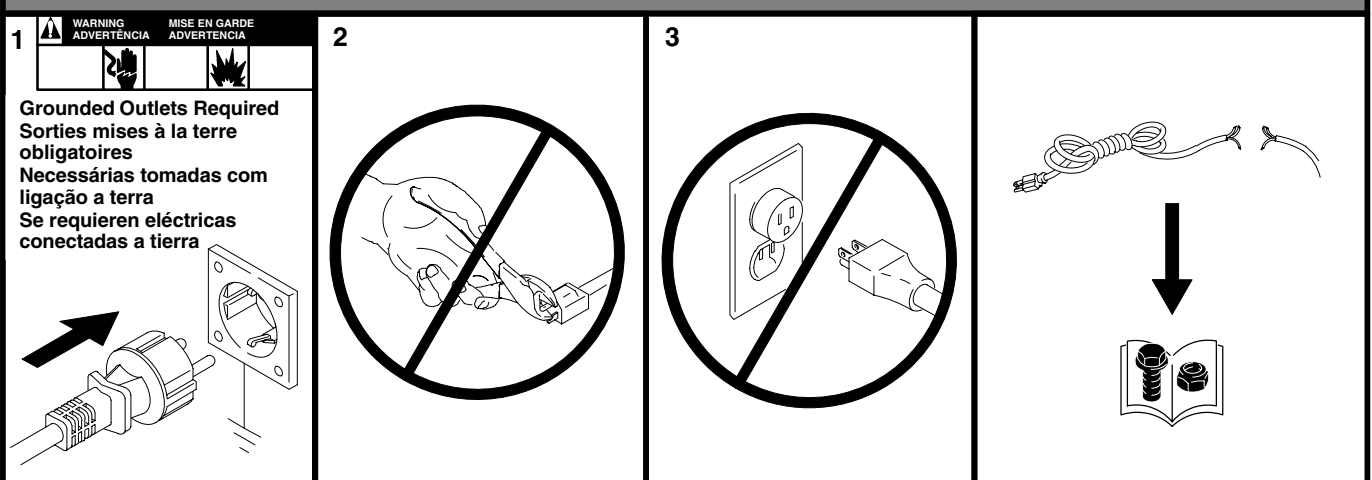

SHUTDOWN / AFZETTEN / ARRÊT / GERÄT ABSCHALTEN

1

MPa/bar/PSI

Pressure Relief
Alívio de pressão
Décharge de pression
Alivio de la presión

2

AutoClean™
309278
 or
 ou
 ou
 o
3-22

3

WARNING **WAARSCHWING**
MISE EN GARDE **WARUNUNG**

4

5

6

7

8

Flush
Descarga
Vidange
Enjuague

9

20 SEC.

FLUSH
DESCARGA
VIDANGE
ENJUAGUE

10

MPa/bar/PSI

Pressure Relief
Alívio de pressão
Décharge de pression
Alivio de la presión

11

FLUSH
 冲洗
 洗淨酒
 경고

12

13

14

15

16

17

Mineral Spirits
Álcool mineral
Essence minérale
Alcohol mineral

18

20 SEC.

WASTE
RESIDUOS
À JETER
DESECHO

19

MPa/bar/PSI

Pressure Relief
Alívio de pressão
Décharge de pression
Alivio de la presión

20

Mineral Spirits
Álcool mineral
Essence minérale
Alcohol mineral

21

TSL

22

DISPLAY

ERROR CODES

(Not available on all sprayers)



<input type="checkbox"/> E = 02	High pressure limit
<input type="checkbox"/> E = 03	Transducer fault
<input type="checkbox"/> E = 04	High line voltage
<input type="checkbox"/> E = 05	High current
<input type="checkbox"/> E = 06	Motor overheated
<input type="checkbox"/> E = 07	> 2000 psi in Timer Mode
<input type="checkbox"/> E = 08	Low line voltage

Turn power OFF/ON to reset
 Gire a potencia OFF/ON para a restauração
 Tournez la puissance OFF/ON à la remise
 Dévuelte a la potencia OFF/ON a la restauración

Service manual
 Manual técnica
 Manuel service
 Manuale servizio



Service
 Assistência técnica
 Service
 Servicio

PRESSURE → GAL/LTR → TIMER ↷



PRESSURE

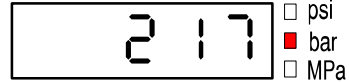

GAL/LTR



TIMER

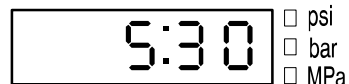

Noise / Ruído / Bruit / Ruido

Power / Potência / Marche / Alimentación . . . 91 dB(A)*
 Pressure / Pressão / Pression / Presión . . . 82 dB(A)*
 * ISO 3744

Graco Standard Warranty Garantia Standard da Graco Garantie standard de Graco Garantía estándar Graco

Graco warrants all equipment referenced in this document which is manufactured by Graco and bearing its name to be free from defects in material and workmanship on the date of sale by an authorized Graco distributor to the original purchaser for use. With the exception of any special, extended, or limited warranty published by Graco, Graco will, for a period of twelve months from the date of sale, repair or replace any part of the equipment determined by Graco to be defective. This warranty applies only when the equipment is installed, operated and maintained in accordance with Graco's written recommendations.

This warranty does not cover, and Graco shall not be liable for general wear and tear, or any malfunction, damage or wear caused by faulty installation, misapplication, abrasion, corrosion, inadequate or improper maintenance, negligence, accident, tampering, or substitution of non-Graco component parts. Nor shall Graco be liable for malfunction, damage or wear caused by the incompatibility of Graco equipment with structures, accessories, equipment or materials not supplied by Graco, or the improper design, manufacture, installation, operation or maintenance of structures, accessories, equipment or materials not supplied by Graco.

This warranty is conditioned upon the prepaid return of the equipment claimed to be defective to an authorized Graco distributor for verification of the claimed defect. If the claimed defect is verified, Graco will repair or replace free of charge any defective parts. The equipment will be returned to the original purchaser transportation prepaid. If inspection of the equipment does not disclose any defect in material or workmanship, repairs will be made at a reasonable charge, which charges may include the costs of parts, labor, and transportation.

THIS WARRANTY IS EXCLUSIVE, AND IS IN LIEU OF ANY OTHER WARRANTIES, EXPRESS OR IMPLIED, INCLUDING BUT NOT LIMITED TO WARRANTY OF MERCHANTABILITY OR WARRANTY OF FITNESS FOR A PARTICULAR PURPOSE.

Graco's sole obligation and buyer's sole remedy for any breach of warranty shall be as set forth above. The buyer agrees that no other remedy (including, but not limited to, incidental or consequential damages for lost profits, lost sales, injury to person or property, or any other incidental or consequential loss) shall be available. Any action for breach of warranty must be brought within two (2) years of the date of sale.

GRACO MAKES NO WARRANTY, AND DISCLAIMS ALL IMPLIED WARRANTIES OF MERCHANTABILITY AND FITNESS FOR A PARTICULAR PURPOSE, IN CONNECTION WITH ACCESSORIES, EQUIPMENT, MATERIALS OR COMPONENTS SOLD BUT NOT MANUFACTURED BY GRACO. These items sold, but not manufactured by Graco (such as electric motors, switches, hose, etc.), are subject to the warranty, if any, of their manufacturer. Graco will provide purchaser with reasonable assistance in making any claim for breach of these warranties.

In no event will Graco be liable for indirect, incidental, special or consequential damages resulting from Graco supplying equipment hereunder, or the furnishing, performance, or use of any products or other goods sold hereto, whether due to a breach of contract, breach of warranty, the negligence of Graco, or otherwise.

FOR GRACO BRAZILIAN/CANADIAN/COLUMBIAN CUSTOMERS

The Parties acknowledge that they have required that the present document, as well as all documents, notices and legal proceedings entered into, given or instituted pursuant hereto or relating directly or indirectly hereto, be drawn up in English.

PARA CLIENTES BRASILEIROS DA GRACO

As partes confirmam que solicitaram que o presente documento, assim como todos os demais documentos, notas e processos legais inseridos, atribuídos ou instituídos de acordo com o mesmo ou relacionados direta ou indiretamente com este documento, sejam redigidos em inglês.

POUR LES CLIENTS DE GRACO AU CANADA

Les parties conviennent qu'elles ont exigé que le présent document, ainsi que tous les autres documents, avis et poursuites judiciaires intervenus, accordés ou institués en relation directe ou indirecte aux termes cités ci-après soient rédigés en anglais.

PARA CLIENTES COLOMBIANOS GRACO

Las partes reconocen que han exigido que el presente documento, como asimismo toda la documentación, notificaciones o procedimientos legales en que se incurra, o bien se instituyan en cumplimiento con el presente documento o en relación directa o indirecta con el mismo, sean redactados en inglés.

ADDITIONAL WARRANTY COVERAGE

Graco does provide extended warranty and wear warranty for products described in the "Graco Contractor Equipment Warranty Program".

COBERTURA DE GARANTIA ADICIONAL

A Graco fornece prorrogação de garantia e garantia de desgaste para os produtos descritos no "Graco Contractor Equipment Warranty Program" (Programa de garantia de equipamento do empreiteiro da Graco).

GARANTIE PROLONGÉE

Graco n'offre pas de garantie prolongée ni de garantie contre l'usure pour les produits décrits dans le "Programme de garantie des équipements pour entrepreneur de Graco".

COBERTURA ADICIONAL DE LA GARANTÍA

Graco ofrece una garantía extendida y una garantía de desgaste para los productos consignados en el "Programa de Garantía de Equipo Graco para Contratistas".

TO PLACE AN ORDER OR FOR SERVICE, contact your Graco distributor,

or call 1-800-690-2894 to identify the nearest distributor.

PARA EFETUAR ENCOMENDAS OU PARA ASSISTÊNCIA TÉCNICA, contate o seu distribuidor da Graco.

POUR PLACER UNE COMMANDE OU DEMANDER DU SERVICE, contactez votre distributeur Graco.

PARA REMITIR UN PEDIDO O SOLICITAR SERVICIO, póngase en contacto con el distribuidor de Graco.

All written and visual data contained in this document reflects the latest product information available at the time of publication. Graco reserves the right to make changes at any time without notice.

Todos os dados escritos e visuais contidos neste documento refletem as mais recentes informações sobre o produto disponíveis na época da publicação. A Graco reserva-se o direito de efetuar alterações em qualquer momento sem aviso prévio.

Toute information écrite et graphique incluse dans ce document reflète les caractéristiques les plus récentes des produits au moment d'aller sous presse. Graco se réserve le droit d'apporter des modifications en tout temps sans avis.

Toda el material escrito y visual contenido en este documento refleja la información de producto más reciente manejada al momento de la publicación. Graco se reserva el derecho de introducir cambios en cualquier momento sin aviso.

Sales Offices: Minneapolis, Detroit
Foreign Offices: Belgium, Korea, Hong Kong, Japan
Escritórios de Vendas: Minneapolis, Detroit
Escritórios estrangeiros: Bélgica, Coréia, Hong Kong, Japão
Bureaux des ventes : Minneapolis, Détroit
International : Belgique, Corée, Hong Kong, Japon
Oficina de ventas: Minneapolis, Detroit
Oficinas internacionales: Bélgica, Corea, Hong Kong, Japón

GRACO INC. P.O. BOX 1441 MINNEAPOLIS, MN 55440-1441

<http://www.graco.com>

PRINTED IN USA 309257 December 2000, Revised 3/2003
IMPRESSO NOS EUA 309257 Dezembro de 2000, Revisado 3/2003
IMPRIMÉ AUX É.-U. 309257 Décembre 2000, Révisé 3/2003
IMPRESO EN EE.UU. 309257 Diciembre de 2000, Revisado 3/2003